

This article was downloaded by:

On: 22 January 2011

Access details: *Access Details: Free Access*

Publisher *Taylor & Francis*

Informa Ltd Registered in England and Wales Registered Number: 1072954 Registered office: Mortimer House, 37-41 Mortimer Street, London W1T 3JH, UK



The Journal of Adhesion

Publication details, including instructions for authors and subscription information:

<http://www.informaworld.com/smpp/title~content=t713453635>

A Temperature-Programmed Desorption Technique for Studying Surface Contamination and Acid-Base Properties of Thick Metal Sheets

E. Peillex^a; F. Gaillard^a; M. Romand^a; J. P. Joly^b; D. Verchere^c

^a Department de Chimie Appliquée et Génie Chimique (CNRS,URA417), Université Claude Bernard, Villeurbanne, Cedex, France ^b Laboratoire d' Application de la Chimie à l'Environnement, LACE, Université Claude Bernard, Villeurbanne, Cedex, France ^c IRSID, Institut de Recherche de la Sidérurgie, Fraissies, France

To cite this Article Peillex, E. , Gaillard, F. , Romand, M. , Joly, J. P. and Verchere, D.(1995) 'A Temperature-Programmed Desorption Technique for Studying Surface Contamination and Acid-Base Properties of Thick Metal Sheets', The Journal of Adhesion, 50: 1, 59 – 69

To link to this Article: DOI: 10.1080/00218469508027113

URL: <http://dx.doi.org/10.1080/00218469508027113>

PLEASE SCROLL DOWN FOR ARTICLE

Full terms and conditions of use: <http://www.informaworld.com/terms-and-conditions-of-access.pdf>

This article may be used for research, teaching and private study purposes. Any substantial or systematic reproduction, re-distribution, re-selling, loan or sub-licensing, systematic supply or distribution in any form to anyone is expressly forbidden.

The publisher does not give any warranty express or implied or make any representation that the contents will be complete or accurate or up to date. The accuracy of any instructions, formulae and drug doses should be independently verified with primary sources. The publisher shall not be liable for any loss, actions, claims, proceedings, demand or costs or damages whatsoever or howsoever caused arising directly or indirectly in connection with or arising out of the use of this material.

A Temperature-Programmed Desorption Technique for Studying Surface Contamination and Acid-Base Properties of Thick Metal Sheets*

E. PEILLEX, F. GAILLARD** and M. ROMAND

Department de Chimie Appliquée et Génie Chimique (CNRS,URA 417), Université Claude Bernard LYON-1, 69622 Villeurbanne Cedex, France

J. P. JOLY

Laboratoire d'Application de la Chimie à l'Environnement, LACE, Université Claude Bernard LYON-1, 69622 Villeurbanne Cedex, France

D. VERCHERE

Institut de Recherche de la Sidérurgie, IRSID, BP 01,42490 Fraissès, France

(Received February 21, 1994; in final form August 29, 1994)

This paper describes how the temperature-programmed desorption (TDP) technique, which is widely used in the fields of surface science and catalysis, has been newly adapted to investigate the thick metallic sheet samples of about 10 cm² area used in adhesion studies. A high frequency induction system has been designed in order to achieve a high heating rate (up to 200 K.s⁻¹) without creating substantial temperature gradients in the sheet. The sample is placed in a secondary vacuum reactor and the gas desorbed is analysed by means of a quadrupole mass spectrometer. The results presented deal with stainless steel and chromium surfaces, subjected to various chemical treatments. The sensitivity and the resolution of the technique presented are shown to be sufficient to study metallic surface contamination and to characterise the acid sites at the surface by desorption of a basic probe molecule such as ammonia.

KEY WORDS: thermal desorption; TPD; stainless steel; chromium; surface; acid-base properties.

INTRODUCTION

A great number of theories have been proposed to take into account all the phenomena involved in polymer-to-metal adhesion. In this field, the importance of surface con-

* Presented at the Seventeenth Annual Meeting of The Adhesion Society, Inc., in Orlando, Florida, U.S.A., February 21–23, 1994.

** Corresponding author.

tamination of the metallic substrate was highlighted a long time ago and studied with various surface analysis techniques such as XPS, AES, SIMS, ISS, FTIR... On the other hand, the main role played by the chemical affinity of a treated metallic surface for some active functions of a polymer is considered in the chemical theory of adhesion, which gained a new interest, some years ago, confirmed by the ever-increasing number of papers dealing with acid-base theory.¹⁻³ Acid-base properties of surfaces have been extensively investigated in catalysis. The techniques mainly used are microcalorimetry, infrared spectroscopy, and thermally-programmed desorption (TPD). Some others such as inverse gas chromatography (IGC) can also be adapted to specific cases. These techniques are generally well suited to study highly-divided solids employed for catalysis purposes, but they need particular adaptations to the surface study of bulky metallic sheets such as those used in the domain of adhesion. In this field, we may note some interesting approaches carried out using XPS.⁴⁻⁷

Temperature-programmed desorption (TPD) is a well-known technique⁸⁻¹¹ which consists of analysing (generally by mass spectrometry) the desorption fluxes of gases evolved from a surface during heating. TPD was widely used for characterising the surface of thin metallic ribbons (flash desorption) and is currently employed to investigate highly-divided solids. The paper cited in Reference 12 gives a complete review of TPD. This technique has not been used in the field of adhesion for studying bulky substrates of low surface areas, mainly because of the difficulty in achieving a uniform temperature throughout the sample in transient conditions merely by the Joule Effect. Nevertheless, a recent work of Somorjai *et al.*¹³ indicates that temperature-programmed desorption of substituted benzenes from zinc oxide and iron oxide overlayers on gold is a valid method to investigate their acid-base properties. In the present work, the problem of heating a thick sample in the secondary vacuum of a glass reactor has been overcome by developing a system using a high-frequency induction device. As shown for the case of stainless steel and chromium samples, this device can be used to investigate, on the one hand, the surface contamination of "as-received" and surface-treated substrates and, on the other hand, the surface reactivity of the metallic sheet, by adsorption-desorption of a probe molecule (ammonia, in this example).

2 EXPERIMENTAL

The device used is schematically represented in the block diagram of Figure 1. The sample is placed in a glass reactor (under 10^{-7} Torr) and is supported by a K-type capillary thermocouple (Ni-Cr and Ni-Cr-Mn-Si wires, 10 cm in length, 50 μ m in diameter) spot welded onto its surface. Therefore, the sample is virtually isolated mechanically and thermally from both the reactor and the heating device. Heating is achieved by a high frequency (1.1 MHz, maximal power 6 kW, manufactured by CFEI, France) system, with a 6-turn inductive coil placed outside the reactor allowing heating rates ranging from 10 to 200 K.s⁻¹ with a small temperature gradient at the sample surface (see the Results section). Desorption from the thermocouple is considered as negligible. The reactor is fitted with a line used to introduce treatment

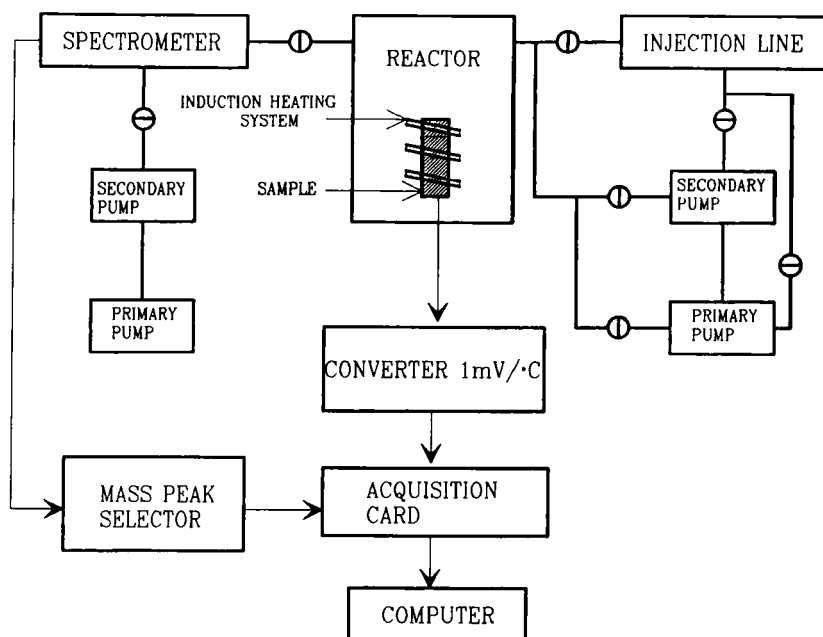

FIGURE 1 Block diagram of the TPD system.

gases (O_2 , for instance) or probe molecules at selected pressures. Before gas introduction, the cell is not purged (with He for instance) but evacuated under 10^{-7} Torr. Analysis of compounds released during the TPD experiment is carried out by means of a quadrupole mass spectrometer (Riber QS100). A peak selector enables the user to collect the data of 4 masses simultaneously. Both spectrometer and thermocouple are interfaced to a personal computer and data processing is performed by home made dedicated program. The reactor and sample attachment are described in more detail in Figure 2.

Figure 3 shows typical changes of the mass spectrometer response and of the temperature of the sample *versus* time during a TPD experiment. The parameters of interest are the temperature at peak maximum (denoted T_m), the heating rate, dT/dt , at T_m (denoted α_m) and the desorption flux of a given species A (dN_A/dt). The flux, dN_A/dt , can be deduced, after calibration, from the mass spectrometer signal. On the other hand, the values of α_m and T_m allow us to calculate the desorption activation energy (denoted E) for species A.¹⁴ For this purpose, the desorption rate (δ) is assumed to follow the first-order kinetic equation:

$$\delta = k \cdot n_A \quad \text{where} \quad k = \nu \cdot \exp(-E/RT)$$

where n_A is the number of moles of A adsorbed, E the desorption activation energy, T the Kelvin temperature, and ν the frequency factor classically chosen close to 10^{13} s^{-1} .

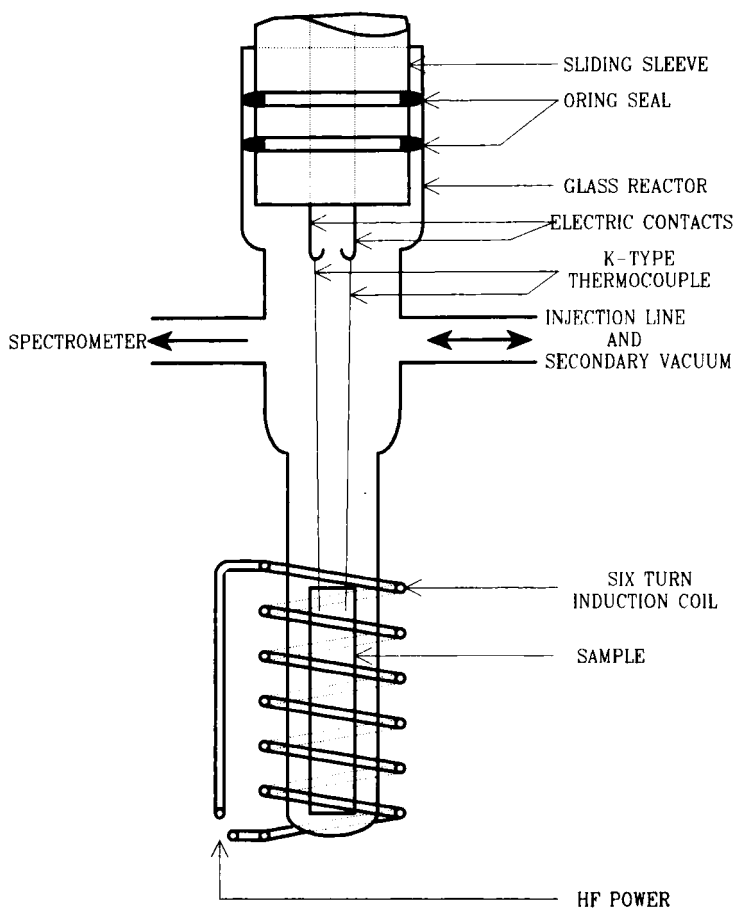

FIGURE 2 Schematic drawing of the TPD reactor.

The desorption flux is, therefore: $dN_A/dt = -dn_A/dt = k \cdot n_A$ where N_A refers to A in the gas phase

At peak maximum: $d^2N_A/dt^2 = -k^2 n_A + n_A \cdot \alpha_m \cdot dk/dT = 0$

This equation can be written: $\alpha_m \cdot d \ln(k)/dT = k$

or: $E/RT_m = \ln(v/\alpha_m) - \ln(E/RT_m^2)$

then: $E = RT_m (\ln(v/\alpha_m) - \ln(\ln(v/\alpha_m)/T_m))$

The value of T_m can be calculated by an iterative process as follows:

$$T_{n+1} = \frac{E}{R \cdot (\ln(v/\alpha_m) - \ln(E/RT_n^2))}$$

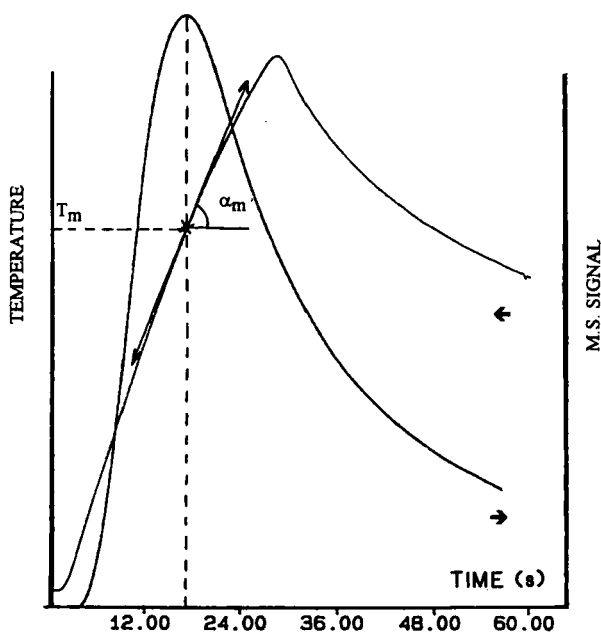

FIGURE 3 Typical TPD curve and parameters of interest.

with the initial value:

$$T_1 = \frac{E}{R \ln(v/\alpha_m)}$$

For instance, Figure 4 (a) shows the desorption activation energies calculated for various values of T_m (for $\alpha = 10 \text{ K} \cdot \text{s}^{-1}$) while Figure 4 (b) shows how T_m varies with the heating rate (for $E = 120 \text{ kJ} \cdot \text{mol}^{-1}$).

The value of the desorption activation energy is of interest since it indicates, for example for a basic probe such as ammonia, the strength of its bond with acidic sites of the substrate surface. Therefore, the value of E gives an evaluation of the relevant acidic sites. On the other hand, the amount of desorbed materials is representative of the number of investigated sites.

During preliminary experiments, the authors performed ammonia desorption from a thin foil of iron, heated by the Joule Effect. Although this experiment proved that mass spectrometry can achieve a sufficient sensitivity it suffers many drawbacks such as:

- the necessity to use thin metallic foils which are not representative of the surface of bulk materials generally of interest in adhesion studies.
- the necessity of welding or soldering the sample to high current copper wire. These wires can also take part in the adsorption/desorption process as shown by blank runs.

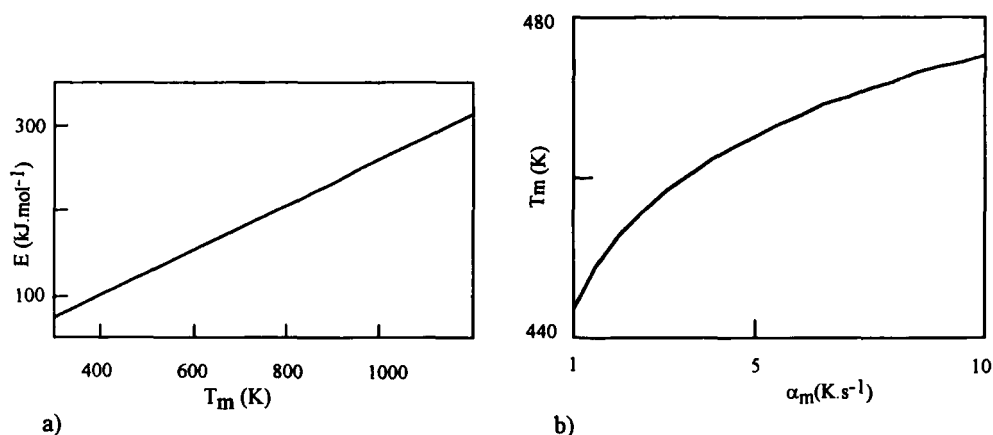

FIGURE 4 Values of the calculated desorption activation energy *versus* T_m (with $\alpha = 10 \text{ K}\cdot\text{s}^{-1}$) (a) Influence of the heating rate on the calculated value of T_m ($E = 120 \text{ kJ}\cdot\text{m}^{-1}$) (b).

—the large thermal gradients in the sample as a result of the thermal conduction in the copper wires.

In order to overcome all these difficulties, this system was no longer employed and heating by a high-frequency device was chosen. A proof of sample surface temperature homogeneity is given in Figure 5 where the thermocouple signals *versus* induction heating time is plotted. The thermocouples are welded respectively at (a) the centre and (b) one extremity of a stainless steel sample ($50 \text{ mm} \times 10 \text{ mm}$, 1 mm thick). The temperature difference does not exceed 10 K over the complete range investigated. Such a result is obtained by adjusting the induction coil (position of the turns and distance between them) with respect to the thermal conductivity of the sample and to its susceptibility of being heated by an inductive system.

The samples studied are AISI 304L (NS22S from Ugine, France) stainless steel and pure (99.7% from Goodfellow, UK) chromium (both $50 \text{ mm} \times 10 \text{ mm}$, 1 mm in thickness). Stainless steel treatments used in this study are:

- degreasing (10 min in acetone ultrasonic bath)
- etching (5 min in 15% HNO_3 , 5% HF , 80% H_2O at room temperature, followed by rinsing with distilled water)
- anodising (galvanostatic mode in a $470 \text{ g}\cdot\text{l}^{-1} \text{H}_2\text{SO}_4$, $400 \text{ g}\cdot\text{l}^{-1} \text{K}_2\text{Cr}_2\text{O}_7$ solution at 340 K, followed by rinsing with distilled water)¹⁵
- thermal oxidising (in the TPD reactor at 1173 K, 20 min, under 10 Torr O_2).

Ammonia adsorption is performed at 353 K, for 10 min, under 10 Torr NH_3 . This temperature of 353 K is chosen mainly to lower the physisorption of ammonia in order to investigate only the strong acidic sites where chemical adsorption occurs. Such sites are likely to be the most important as far as adhesion is concerned.

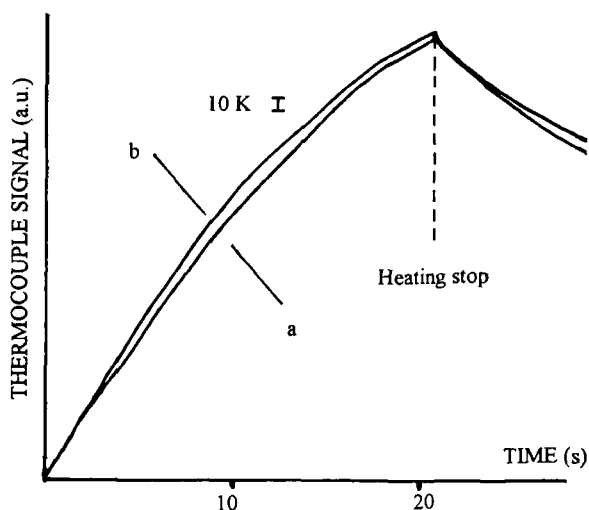

FIGURE 5 Variation versus induction heating time of the signal of a K-Type thermocouple spotwelded at (a) the centre and (b) the extremity of a stainless steel sample (50 mm \times 10 mm, 1 mm thick).

3 RESULTS AND DISCUSSION

In order to determine the capabilities of such a technique to study the surface contamination of metallic substrates, 304L samples are investigated by TPD and variations of the signal associated with the $m/z = 44$ amu (CO_2^+) are followed as a function of sample temperature. The TPD curves, reported in Figure 6, are those obtained for samples (a) "as-received", (b) after degreasing, and (c) after etching. These results emphasise the sensitivity of TPD and its potential in studies on surface contamination and adhesion, since similar investigations can be carried out, for example, with adsorbed water as shown by the results compiled in Figure 7. The desorption activation energies reported are calculated from the TPD curves, for water adsorbed on stainless steel samples (a) "as received", (b) degreased, (c) etched, (d) anodised, (e) thermally oxidised and (f) on chromium. No explanation is given, for the time being, for the first two TPD peaks as the values of desorption activation energies are too high to advocate the hypothesis of desorption of only physisorbed water. The TPD peak at higher temperature is consistent with a mechanism of surface dehydroxylation, known to evolve water from the surface and to create Lewis acid sites¹⁶.

The anodising of stainless steels has been shown to be an efficient method of improving their properties of adhesion to epoxy resins.^{15,17} Such an improvement can be attributed, among other causes, to changes in acid-base properties of the steel surface induced by the electrochemical treatment. The results presented in Figure 8 are relative to stainless steel samples (a) chemically etched, (b) anodised at 0.2 mA.cm^{-2} , (c) anodised at 1 mA.cm^{-2} , (d) thermally oxidised and (e) to chromium, respectively. Prior to the TPD experiment, these samples underwent ammonia adsorption as described above. Such a probe has been chosen because it is small basic molecule, widely used to

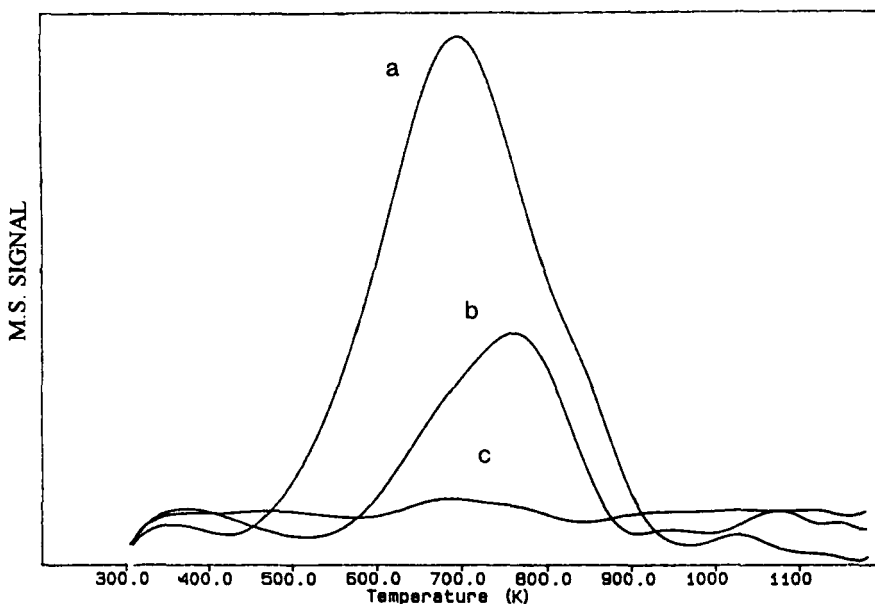

FIGURE 6 TPD curves ($m/z = 44$ amu, CO_2^+) of 304L samples (50 mm \times 10 mm thick) (a) "as-received", (b) after solvent degreasing, and (c) after HF-HNO₃ etching. After treatment, samples are placed into the reactor which is evacuated to 10^{-7} Torr before TPD.

test the surface acidity of compounds used for catalysis purposes.^{18,19} The ammonia evolved is monitored by measuring the height of the peak at $m/z = 17$ amu (NH_3^+). The spectra are corrected for the contribution of water ($m/z = 18$ amu) due to its fragmentation in the mass spectrometer. Similar results obtained by comparing $m/z = 15$ (NH^+), 16 (NH_2^+), and 17 amu prove that the TPD peaks recorded are representative of ammonia desorbed from the sample. The TPD peaks appearing at various temperatures prove the existence of various modes for ammonia adsorption on acidic sites of oxides as reported in the literature.²⁰ For the etched sample, a small TPD peak is observed at T_m about 490 K. For the sample anodised at 0.2 mA.cm^{-2} a higher peak is detected at $T_m = 430$ K with a shoulder at higher temperature (about 540 K). For the sample anodised at 1.0 mA.cm^{-2} , two large desorption peaks appear at $T_m = 440$ and 610 K, respectively. The corresponding desorption activation energies are about 120 and 150 kJ.mol^{-1} , which indicate that ammonia is strongly bonded to the acidic sites created at the anodised steel surface. The number of these sites is initially low for the etched sample and increases when the steel is anodised at 0.2 mA.cm^{-2} and then at 1.0 mA.cm^{-2} . Surface characterisation of the anodised stainless steel has been performed by AES, glow discharge optical spectroscopy (GDOS), and low energy electron-induced x-ray spectroscopy (LEEIXS²¹). The thickness of the films formed at 0.2 mA.cm^{-2} is about 43 nm and those of films formed at 1.0 mA.cm^{-2} is about 86 nm. All the films of this kind exhibit a high porosity and the thicker the film, the more its surface is enriched in chromium.²² The differences in ammonia TPD peaks (increasing by a factor of about 5 when anodising current passes from 0.2 to 1.0 mA.cm^{-2}) cannot

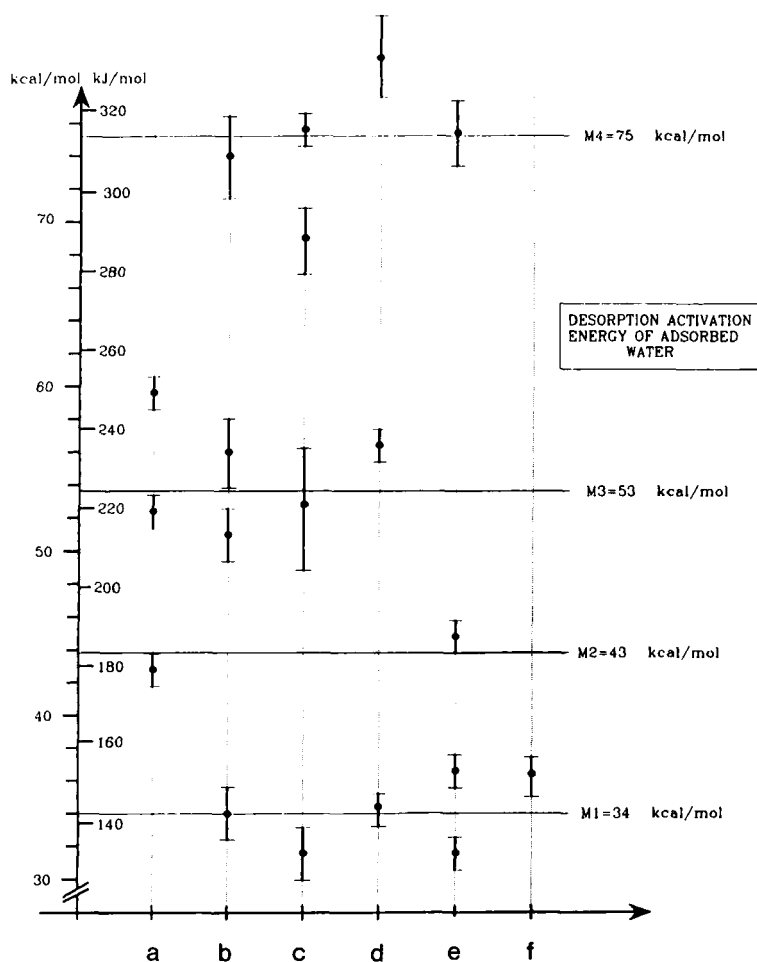

FIGURE 7 Desorption activation energies for water adsorbed on stainless steel samples (a) "as received", (b) solvent degreased, (c) chemically etched, (d) electrochemically anodised, (e) insitu thermally oxidised and (f) on chromium.

be justified only by the increased thickness (by a factor of about 2) of the porous oxide layer. Previous works^{15,17} proved that surface chromium enrichment of the stainless steel is the major parameter influencing the durability of its bond with an epoxy resin.

Samples etched, anodised at $0.2 \text{ mA}\cdot\text{cm}^{-2}$ and anodised at $1.0 \text{ mA}\cdot\text{cm}^{-2}$ were bonded to an epoxy resin (Ciba AY103 with hardener HY991, cured 2 h at 80°C) in order to obtain three-point flexure test²³ specimens. The adhesion of epoxy resins to so-treated samples follows the same trend as the ammonia TPD: $1.0 \text{ mA}\cdot\text{cm}^{-2}$ anodised $> 0.2 \text{ mA}\cdot\text{cm}^{-2}$ anodised \gg etched samples. For the three-point flexure test, the ultimate displacement before sample failure (denoted d_{max}) represents the resistance of the bonded joint. The values of d_{max} recorded for the samples etched, anodised at $0.2 \text{ mA}\cdot\text{cm}^{-2}$, and anodised at $1.0 \text{ mA}\cdot\text{cm}^{-2}$ are, respectively, $0.35 \text{ mm} \pm 35\%$, $1.5 \text{ mm} \pm$

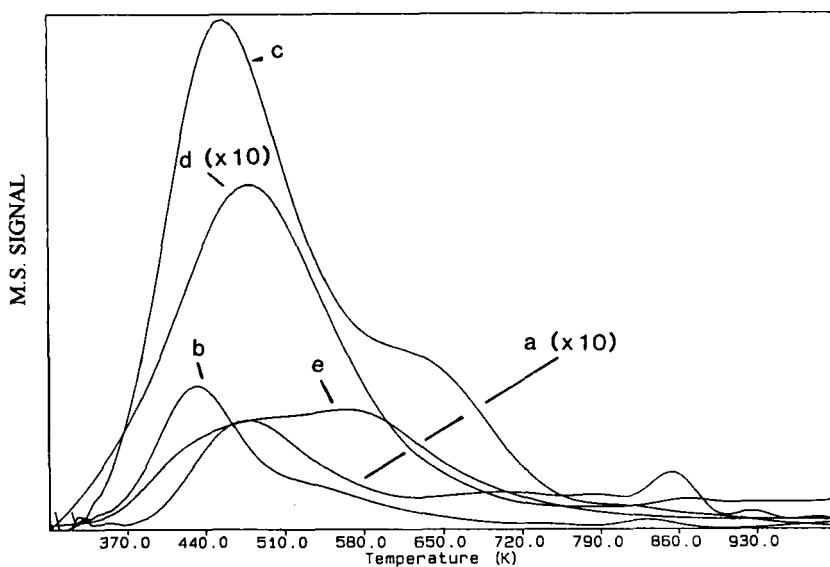

FIGURE 8 TPD curve ($m/z = 17$ amu) of stainless steel samples (a) chemically etched, (b) anodised at 0.2 mA.cm^{-2} , (c) anodised at 1 mA.cm^{-2} , (d) thermally oxidised and (e) of chromium. All samples were previously subjected to ammonia adsorption (10 Torr, 80°C , 10 min). Scale for samples (a) and (d) is expanded by a factor 10.

34%, and $2.5 \text{ mm} \pm 18\%^{24}$. Such a correlation between adhesion and TDP data confirms that this new application of the TDP technique can be of great help in adhesion science, both in a predictive way, and as a fundamental research tool. Of course, some non-chemical parameters, such as the porosity of the layers created by the surface treatment, can also play a role in adhesion.

4 CONCLUSIONS

The results presented in this paper show an application of the TPD technique with a high-frequency heating system, thus allowing the study of thick metallic samples. The sensitivity and resolution of the technique are suitable for the study of such low-surface-area samples. Both surface contamination studies and desorption of probe molecules are now possible. As the quality of TPD spectra is good, it is possible to gain quantitative data and to calculate the desorption activation energies (E) associated with the major TPD peaks. For instance, the value of E calculated from the desorption temperature of some basic probes such as ammonia is related to the strength of the acidic sites at the sample surface. This technique can be extended to a wide variety of probe molecules (acidic or basic) and to the study of various surface contamination, hydration, specific reactions... Such a technique should be, in the near future, of great help in fundamental studies of adhesion, as its potential allows us to describe the surface of a treated metal in terms of

its nature (acidic or basic), as well as the number and the strength of sites. The adsorption and thermal desorption of selected organic model molecules can also be a good technique to investigate the chemical interactions between a treated metallic surface and an adhesive. In order to understand better epoxy resin adhesion on various substrates, Somorjai *et al.*²⁵ used TPD to elucidate the interaction of some glycidyl and phenoxy compounds with iron oxide and zinc oxide thin films deposited on gold. The use of high-frequency heating enables us to carry out such a study on bulky samples which are more representative of the substrates employed in adhesion studies.

Acknowledgements

The authors wish to thank Mr. R. de Framond and the Cie Francaise d'Electrothermie Industrielle (CFEI, Seyssinet, France) for their help in the high-frequency technology, and Dr. N. S. Prakash (CNRS, Université de Lyon, France) for editing this paper.

References

1. F. M. Fowkes, *Microscopic Aspects of Adhesion and lubrication*, J. M. Georges, Ed., Tribology Series N° 7 (Elsevier, Amsterdam, 1982), p. 119.
2. W. B. Jensen, *J. Adhesion Sci. Technol.*, **5** (1), 1 (1991).
3. L. H. Lee, *Fundamentals of Adhesion*, L. H. Lee, Ed. (Plenum Press, New York, 1991), P. 349.
4. G. W. Simmons, B. C. Beard, *J. Phys. Chem.*, **91**, 1143 (1987).
5. J. F. Watts, M. M. Chehimi, M. Gibson, *J. Adhesion*, **39**, 145 (1992).
6. G. G. Kurbatov, E. Darque-Ceretti, M. Aucouturier, *Surf. Interface Anal.*, **18**, 811 (1992).
7. W. M. Mullins, B. L. Averbach, *Surf. Sci.*, **206**, 52 (1988).
8. G. Ehrlich, *Adv. Catal.*, **14**, 255 (1963).
9. P. A. Readhead, *Vacuum*, **12**, 203 (1963).
10. G. Carter, *Vacuum*, **12**, 245 (1962).
11. M. Smutek, S. Cerny, F. Buzek, *Adv. Catal.*, **24**, 343 (1975).
12. P. Malet, *Spectroscopic Characterization of Heterogeneous Catalysts*, J. L. G. Fiero, Ed., Studies in Surface Sciences and Catalysis, Vol 57 B (Elsevier, Amsterdam, 1990), Chap. VI.
13. M. Nakazawa, G. A. Somorjai, *Appl. Surf. Sci.*, **68**, 517 (1993).
14. A. Perrard, J. P. Joly, *Vacuum*, **39**, (6), 551 (1989).
15. R. P. Haak, T. Smith, *Int. J. Adhesion and Adhesives*, **3**(1), 15 (1983).
16. J. B. Peri, *J. Phys. Chem.*, **69** (1), 231 (1965).
17. F. Gaillard, M. Romand, *Surf. Interface Anal.*, **12**, 491 (1988).
18. A. A. Davydov, *Infrared Spectroscopy of Adsorbed Species on the Surface of Transition Metal Oxides*, C. H. Rochester, Ed. (J. Wiley & Sons, London, 1990), p. 24.
19. M. C. Kung, H. H. Kung, *Catal. Rev. Sci. Eng.*, **27** (3), 425 (1985).
20. A. Auroux, A. Gervasini, *J. Phys. Chem.*, **94**, 6371 (1990).
21. M. J. Romand, F. Gaillard, M. Charbonnier, D. S. Urch, *Adv. X-ray Analysis*, Vol. 34, C. S. Barret, Ed. (Plenum, New York, 1991), P. 105.
22. F. Gaillard, M. Romand, H. Hocquaux, J. S. Solomon, *Surf. Interface Anal.*, **10**, 163 (1987) 163.
23. A. Roche, F. Gaillard, M. Romand and M. von Fahnestock, *J. Adhesion Sci. Technol.*, **1** (2), 145 (1987).
24. F. Gaillard, Thesis, University of Lyon (1987).
25. M. Nakazawa, G. A. Somorjai, *Appl. Surf. Sci.*, **68**, 539 (1993).